

MicroDosage System (MDS)

for continuous lubrication of high-speed spindles
with minimum quantities of oil from 0.5 to 5 mm³/min

Assembly instructions acc. to EC Dir. 2006/42/EC
for partly completed machinery with associated operating instructions

EN

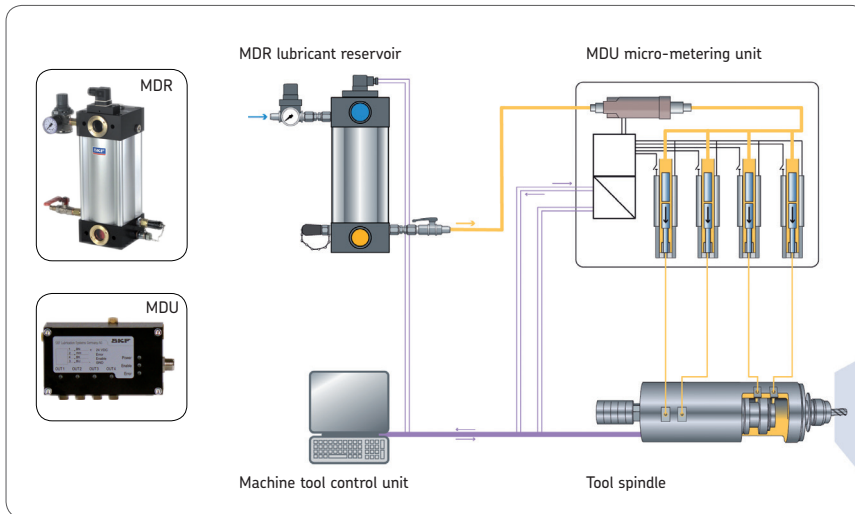

Masthead

These assembly instructions with associated operating instructions according to EC Machinery Directive 2006/42/EC are an integral part of the described product and must be kept for future use.

These assembly instructions with associated operating instructions have been prepared in accordance with the established standards and rules for technical documentation, VDI 4500 and EN 292.

© SKF Lubrication Systems Germany GmbH

This documentation is protected by copyright. SKF Lubrication Systems Germany GmbH reserves all rights, including those to the photo-mechanical reproduction, duplication, and distribution by means of special procedures (e.g., data processing, data media, and data networks) of this documentation in whole or in part.

Subject to changes in contents and technical information.

Service

If you have technical questions, please contact the following addresses:

SKF Lubrication Systems Germany GmbH

Berlin Plant

Motzener Strasse 35/37
12277 Berlin
Germany
Tel. +49 (0)30 72002-0
Fax +49 (0)30 72002-111
lubrication-germany@skf.com
www.skf.com/lubrication

Hockenheim Plant

2. Industriestrasse 4
68766 Hockenheim
Germany
Tel. +49 (0)62 05 27-0
Fax +49 (0)62 05 27-101
lubrication-germany@skf.com
www.skf.com/lubrication

Table of contents

Assembly instructions

MicroDosage System (MDS)	1	3. Overview	16	4.4.2 Assembly drawing with minimum installation dimensions	27
Service	3	3.1 SKF microdosage system	16	4.4.3 Capillary line connection	29
Information concerning EC Declaration of Conformity and EC Declaration of Incorporation	6	3.2 MDU micro-metering unit	17	4.4.4 Arrangement of capillary lines	30
Explanation of symbols and signs	7	3.3 MDR lubricant reservoir designs	18	4.5 Main lubricant line and venting	30
1. Safety instructions	8	4. Assembly	19	4.5.1 Venting the main lubricant line and MDU micro-metering unit	31
1.1 Intended use	8	4.1 General information	19	4.6 Note on the rating plate	33
1.2 Authorized personnel	9	4.2 Setup and attachment	20	4.6.1 MDU rating plate	33
1.3 Electric shock hazard	9	4.2.1 General information on lubrication line arrangement	20	4.6.2 MDR rating plate	33
1.4 System pressure hazard	10	4.3 MDR lubricant reservoir	21		
1.5 Compressed air hazard	10	4.3.1 Attachment of MDR lubricant reservoir	22		
1.6 Warranty and liability	10	4.3.2 Assembly drawing with minimum installation dimensions	22		
1.7 Existing residual risks	11	4.3.3 Electrical fill level indicator	23		
2. Lubricants	13	4.3.4 Initial filling and venting of the MDR lubricant reservoir	23		
2.1 General information	13	4.3.5 Connecting compressed air connection	25		
2.2 Selection of lubricants	13	4.4 MDU micro-metering unit	26		
2.3 Approved lubricants	14	4.4.1 Attachment of the MDU micro-metering unit	26		
2.4 Lubricants and the environment	15				
2.5 Lubricant hazards	15				

Operating instructions

Microdosage system (MDS)	35	6. Operation	45	9. Malfunctions	58
1. Safety instructions	36	6.1 General information	45	9.1 General	58
1.1 General information	36	6.2 Microdosage system parameters	46	9.2 Malfunctions, causes, and remedies	59
1.2 Disclaimer of liability	36	6.2.1 Configuring the system	47	9.3 Questions and answers on using the SKF microdosage system	59
2. Lubricants	36	6.2.2 Determining quantity of lubricant	47		
3. Transport, delivery, and storage	37	6.3 Commissioning/venting the system	48	10. Technical data	61
3.1 Lubrication units	37	6.3.1 Venting the system	48	10.1 MDU micro-metering unit	61
3.2 Electronic and electrical devices	37	6.3.2 Filling spindle lubricant ducts	50	10.2 MDR lubricant reservoir	61
3.3 General information on storage	37	6.4 Calibration of the system	51		
4. Assembly	38	6.4.1 General	51	11. Accessories	62
4.1 Information on assembly	38	6.4.2 Manual calibration	51		
4.2 Installation and use on spindles	38	6.5 External adjustment of volumetric flow	52		
4.2.1 Spindle design	38	6.4.3 Automatic calibration	52		
4.2.2 Lubricant quantity	40	7. Shutdown and disposal	55		
4.2.3 Filling lubricant ducts in the spindle	41	7.1 Temporary shutdown	55		
5. Design and function	42	7.2 Permanent shutdown	55		
5.1 General information	42	8. Maintenance and service	56		
5.2 Principle of the SKF microdosage system	43	8.1 General information	56		
		8.2 Maintenance and repair	57		

Information concerning EC Declaration of Conformity and EC Declaration of Incorporation

The products, metering unit **MDU** lubricant reservoir **MDR** of the minimal quantity lubrication system **MDS** SKF microdosage system are hereby confirmed to comply with the essential protection requirements stipulated by the following Directive(s) of the Council on the approximation of laws of the Member States:

- **Machinery Directive 2006 2006/42/EG**
- **Electromagnetic Compatibility 2014/30/EU**
- **Low Voltage Devices 2014/35/EU**
- **RoHS II Directive 2011/65/EU**

Notes:

- (a) This declaration certifies compliance with the aforementioned Directives but does not constitute a guarantee of characteristics.
- (b) The safety instructions in the documentation included with the products must be observed.
- (c) The commissioning of the products here certified is prohibited until the machine, tool, or similar in which the product is installed conforms with the provisions and requirements of the applicable Directives.

- (d) The operation of the products at non-standard supply voltage, as well as non-adherence to the installation instructions, can negatively impact the EMC characteristics and electrical safety.

We further declare:

- The aforementioned products are, according to **EC Machinery Directive 2006/42/EC, Annex II Part B**, designed for installation in machinery / for incorporation with other machinery to form a machine. Within the scope of the EC Directive, commissioning shall be prohibited until the machinery in which these products are installed conforms with the provisions of this Directive.
- The aforementioned products may, with reference to **EC Directive 97/23/EC concerning pressure equipment**, only be used in accordance with their intended use and in conformity with the instructions provided in the documentation. The following must be observed in this regard:

The products are neither designed nor approved for use in conjunction with fluids of Group 1 (Dangerous Fluids) as defined in Article 2, Para. 2 of Directive 67/548/EEC of June 27, 1967. The products are neither designed nor approved for use in conjunction with gases, liquefied gases, pressurized gases in solution, vapors, or and such fluids whose vapor pressure exceeds normal atmospheric pressure (1013 mbar) by more than 0.5 bar at their maximum permissible temperature. When used in conformity with their intended use, the products supplied by SKF Lubrication Systems Germany GmbH do not reach the limit values listed in Article 3, Para. 1, Clauses 1.1 to 1.3 and Para. 2 of Directive 97/23/EC. They are therefore not subject to the requirements of Annex 1 of the Directive. Consequently, they do not bear a CE marking in respect of Directive 97/23/EC. SKF Lubrication Systems Germany GmbH classifies them according to Article 3, Para. 3 of the Directive. The Declaration of Conformity and Incorporation forms part of the product documentation and is supplied together with the products.

Explanation of symbols and signs

You will find these symbols, which warn of specific dangers to persons, material assets, or the environment, next to all safety instructions in these assembly and operating instructions. Please heed these instructions and proceed with special care in such cases. Please forward all safety instructions to other users.

Instructions placed directly on the product, such as:

- Rotation arrows
 - Fluid connection labels
- must be followed and kept in fully legible condition.







You are responsible!

Please read the assembly and operating instructions thoroughly and follow the safety instructions.

Note: Not all the symbols listed are necessarily used in these instructions.



Hazard symbols

-  General hazard
DIN 4844-2-W000
-  Electrical voltage/current
DIN 4844-2-W008
-  Hot surface
DIN 4844-2-W026
-  Danger of being drawn into machinery
BGV 8A
-  Slipping hazard
DIN 4844-2-W028

Safety signal words and their meaning

Signal word	Meaning
Danger!	Risk of serious injury or death
Warning!	Risk of damage to property and the environment
Note!	Provides additional information

Informational symbols

-  Note
 - Prompts an action
 - Used for itemizing
 - ➔ Refers to other facts, causes, or consequences
 -  Provides additional information
 -  Environmentally sound disposal

1. Safety instructions

 The operator of the described product must ensure that the assembly instructions are read and understood by all persons tasked with the assembly, operation, maintenance, and repair of the product. The assembly instructions must be kept readily available.

 Note that the assembly instructions form part of the product and must accompany the product if sold to a new owner.

The described product is manufactured in accordance with the generally accepted rules and standards of industry practice and with occupational safety and accident prevention regulations. Risks may, however, arise from its usage and may result in physical harm to persons or damage to other material assets. Therefore the product may only be used in proper technical condition and in observance of the assembly instructions. In particular, any malfunctions which may affect safety must be remedied immediately.

 In addition to the assembly instructions, statutory regulations and other general regulations for accident prevention and environmental protection must be observed and applied.

1.1 Intended use

 All products from SKF Lubrication Systems Germany GmbH may be used only for their intended purpose and in accordance with the information in the product's assembly instructions.

The **SKF microdosage system MDS**, together with the products **MDU micro-metering unit** and **MDR lubricant reservoir**, is used to supply lubricant to high-speed spindles and high-speed bearings.

The plastic or stainless steel capillary lines required between the MDU and the lubrication points must have an internal diameter of 0.5 mm and cannot have an overall length greater than 4 m.

The oils used must be filtered; prescribed filter rating $\leq 5 \mu\text{m}$.

Any other use is deemed non-compliant with the intended use and could result in damage, malfunction, or even injury.

In particular, the described products are neither designed nor approved for use in conjunction with fluids of Group 1 (Dangerous Fluids) as defined in Article 2, Para. 2 of Directive 67/548/EEC of June 27, 1967.

The described products are neither designed nor approved for use in conjunction with gases, liquefied gases, pressurized gases in solution, vapors, or and such fluids whose vapor pressure exceeds normal atmospheric pressure (1013 mbar) by more than 0.5 bar at their maximum permissible temperature.

Unless specially indicated otherwise, products from SKF Lubrication Systems Germany GmbH are not approved for use in potentially explosive areas as defined in the ATEX Directive 94/9/EC.

1.2 Authorized personnel

Only qualified technical personnel may install, operate, maintain, and repair the products described in the assembly instructions. Qualified technical personnel are persons who have been trained, assigned, and instructed by the operator of the final product into which the described product is incorporated. Such persons are familiar with the relevant standards, rules, accident prevention regulations, and assembly conditions as a result of their training, experience, and instruction. They are qualified to carry out the required activities and in doing so recognize and avoid any potential hazards.

The definition of qualified personnel and the prohibition against employing non-qualified personnel are laid down in DIN VDE 0105 and IEC 364.

1.3 Electric shock hazard

Electrical connections for the described product may only be established by qualified and trained personnel authorized to do so by the operator, and in observance of the local conditions for connections and local regulations (e.g., DIN, VDE). Serious injury or death and property damage may result from improperly connected products.



Danger!

Performing work on an energized product may result in serious injury or death.

Assembly, maintenance, and repair work may only be performed on products that have been de-energized by qualified technical personnel. The supply voltage must be switched off before opening any of the product's components.

**Note!**

The MDU metering unit contains electronic components that can be destroyed by accidental electrostatic charge or discharge (ESD). To prevent possible damage due to ESD, hands and any tools must be discharged on a bare grounded position on the installation site prior to performing any work in the area of the opened control unit's circuit board. Conductors or component connections within the device must not be touched under any circumstances.

1.4 System pressure hazard

**Danger!**

Centralized lubrication systems are pressurized during operation. Centralized lubrication systems must therefore be depressurized before starting assembly, maintenance, or repair work, or any system modifications or system repairs.

1.5 Compressed air hazard

The lubricant reservoir is pressurized with compressed air.

**Danger!**

The described product is pressurized during operation. The product must therefore be depressurized before starting assembly, maintenance or repair work, or any system modifications or system repairs.

1.6 Warranty and liability

SKF Lubrication Systems Germany GmbH assumes no warranty or liability for the following:

- o Non-compliant usage
- o Improper assembly, configuration, filling, disassembly, or improper operation
- o Use of unsuitable or contaminated lubricants
- o Maintenance and repair work performed improperly or not performed at all
- o Use of non-original SKF components or spare parts
- o Alterations or modifications performed without written approval from SKF Lubrication Systems Germany GmbH
- o Results of improper response to malfunctions
- o Independent modification of system components
- o Non-compliance with the instructions for transport and storage

1.7 Existing residual risks (residual risk assessment)

Residual risk	Remedy
Life cycle: Assembly	
Manual filling: lubricant discharge from the pressure regulating valve of the lubricant reservoir in case of overfilling	<ul style="list-style-type: none"> • Perform filling of the lubricant reservoir carefully and stop once the “MAX fill level” (sight glass on lubricant reservoir) or electrical max. signal is reached.
Risk of slipping due to contamination of floor by spilled or leaked lubricant	<ul style="list-style-type: none"> • Proceed carefully when filling the lubricant reservoir using a filler coupling. • Promptly apply suitable binding agents and remove the leaked or spilled lubricant • Follow statutory and company regulations for the handling of lubricants
Tearing/damage to supply, compressed air, and lubricant lines when installed on moving machine components.	<ul style="list-style-type: none"> • If possible, do not install on moving machine parts; If this cannot be avoided, use flexible supply, compressed air, and lubricant lines.
Life cycle: Commissioning/operation	
Lubricant spraying out due to faulty installation of fittings/screw unions on lubricant lines	<ul style="list-style-type: none"> • Tighten all fittings/screw unions with the appropriate torques (where specified). Use fittings/screw unions and lubricant lines suitable for the indicated operating pressures. Check all fittings/screw unions and lubricant lines for correct connection and damage before commissioning
Risk of slipping due to contamination of floor by spilled or leaked lubricant	<ul style="list-style-type: none"> • Proceed carefully when filling the lubricant reservoir using a filler coupling. • Promptly apply suitable binding agents and remove the leaked or spilled lubricant • Follow statutory and company regulations for the handling of lubricants

Residual risk	Remedy
Life cycle: Setup, retrofit	
Risk of slipping due to contamination of floor by spilled or leaked lubricant	<ul style="list-style-type: none"> • Proceed carefully when filling the lubricant reservoir using a filler coupling. • Promptly apply suitable binding agents and remove the leaked or spilled lubricant. • Follow statutory and company regulations for the handling of lubricants.
Life cycle: Malfunctions, fault-finding	
Risk of slipping due to contamination of floor by spilled or leaked lubricant	<ul style="list-style-type: none"> • Proceed carefully when filling the lubricant reservoir using a filler coupling. • Promptly apply suitable binding agents and remove the leaked or spilled lubricant. • Follow statutory and company regulations for the handling of lubricants.
Life cycle: Maintenance, repair	
Risk of slipping due to contamination of floor by spilled or leaked lubricant	<ul style="list-style-type: none"> • Proceed carefully when filling the lubricant reservoir using a filler coupling. • Promptly apply suitable binding agents and remove the leaked or spilled lubricant. • Follow statutory and company regulations for the handling of lubricants.
Life cycle: Decommissioning, disposal	
Contamination of the environment with lubricant and components that have come into contact with lubricant	<ul style="list-style-type: none"> • Properly dispose of lubricants and components that have come into contact with lubricants. Follow the statutory and company regulations for the handling of lubricants.
Risk of slipping due to contamination of floor by spilled or leaked lubricant	<ul style="list-style-type: none"> • Proceed carefully when filling the lubricant reservoir using a filler coupling. • Promptly apply suitable binding agents and remove the leaked or spilled lubricant. • Follow statutory and company regulations for the handling of lubricants.

2. Lubricants

2.1 General information



All products from SKF Lubrication Systems Germany GmbH may be used only for their intended purpose and in accordance with the information in the product's assembly instructions.

Intended use is the use of the products for the purpose of providing centralized lubrication/ lubrication of bearings and friction points with lubricants within the physical usage limits which can be found in the documentation for the device, e.g., assembly instructions/operating instructions and the product descriptions, e.g., technical drawings and catalogs. Particular attention is called to the fact that hazardous materials of any kind, especially the materials classified as hazardous by EC Directive 67/548/EEC, Article 2, Para. 2, may only be filled into SKF centralized lubrication systems and components and delivered and/or distributed with the same after consultation

with and written approval from SKF Lubrication Systems Germany GmbH. No products manufactured by SKF Lubrication Systems Germany GmbH are approved for use in conjunction with gases, liquefied gases, pressurized gases in solution, vapors, or such fluids whose vapor pressure exceeds normal atmospheric pressure (1013 mbar) by more than 0.5 bar at their maximum permissible temperature.

Other media which are neither lubricant nor hazardous substance may only be fed after consultation with and written approval from SKF Lubrication Systems Germany GmbH. SKF Lubrication Systems Germany GmbH considers lubricants to be an element of system design that must always be factored into the selection of components and the design of centralized lubrication systems. The lubricating properties of the lubricants are critically important in making these selections.

2.2 Selection of lubricants



Observe the instructions from the machine manufacturer regarding the lubricants that are to be used.



Note!

The amount of lubricant required at a lubrication point is specified by the spindle or machine manufacturer. It must be ensured that the required quantity of lubricant is provided to the lubrication point. The lubrication point may otherwise not receive adequate lubrication, which can lead to damage and failure of the bearing.

Selection of a lubricant suitable for the lubrication task is made by the spindle/machine manufacturer and/or the operator of the machine/system in cooperation with the lubricant supplier. When selecting a lubricant, the type of spindle/bearing/friction points, the expected load during operation,

and the anticipated ambient conditions must be taken into account. All economic and environmental aspects must also be considered.

 If required, SKF Lubrication Systems Germany GmbH can help customers to select suitable components for the conveyance of the selected lubricant and to plan and design their centralized lubrication system.

Please contact SKF Lubrication Systems Germany GmbH if you have further questions regarding lubricants. It is possible for lubricants to be tested in the company's laboratory for their suitability for pumping in centralized lubrication systems (e.g., "bleeding"). You can request an overview of the lubricant tests offered by SKF from the company's Sales department.

2.3 Approved lubricants



Note!

Only lubricants approved for the product may be used. Unsuitable lubricants can lead to failure of the product and to property damage.



Note!

Different lubricants must not be mixed together. Doing so can cause damage and require extensive cleaning of the product/centralized lubrication system. It is recommended that an indication of the lubricant in use be attached to the lubricant reservoir in order to prevent accidental mixing of lubricants.

The product described here can be operated using lubricants that meet the specifications in the technical data.

Note that in rare cases, there may be lubricants whose properties are within the permissible limits values but whose other characteristics render them unsuitable for use in

centralized lubrication systems. For example, synthetic lubricants may be incompatible with elastomers.

Oils with a viscosity different than those in Table 1 should be avoided because the metering system cannot be ensured to function properly with them.

Oils with solid additives must not be used, since with these oils there is a risk that the solid particles will deposit within the metering unit and could cause clogging of the metering unit.

Approved oils, Table 1

Requirement	Values
Recommended oil purity level	13/10 (ISO 4406) or: Class 4 (NAS 1638)
Recommended ISO VG class	32 ... 68 Based on 40 °C
Approved additives	EP additives
Prohibited additives	Solids

2.4 Lubricants and the environment



Note!

Lubricants can contaminate soil and waterways. Lubricants must be used and disposed of properly. Observe the local regulations and laws regarding the disposal of lubricants.

It is important to note that lubricants are environmentally hazardous, flammable substances which require special precautionary measures during transport, storage, and processing.

Consult the safety data sheet from the lubricant manufacturer for information regarding transport, storage, processing, and environmental hazards of the lubricant that will be used.

The safety data sheet for a lubricant can be requested from the lubricant manufacturer.

2.5 Lubricant hazards



Danger!

Centralized lubrication systems must always be free of leaks. Leaking lubricant is hazardous due to the risk of slipping and injury. Beware of any lubricant leaking out during assembly, operation, maintenance, or repair of centralized lubrication systems. Leaks must be sealed off without delay.

Lubricant leaking from centralized lubrication systems is a serious hazard. Leaking lubricant can create risks that may result in physical harm to persons or damage to other material assets.



Follow the safety instructions on the lubricant's safety data sheet.

Lubricants are hazardous substances. Follow the safety instructions on the lubricant's safety data sheet. The safety data sheet for a lubricant can be requested from the lubricant manufacturer.

3. Overview

3.1 Overview of the SKF microdosage system

Application example of the microdosage system on a machine tool

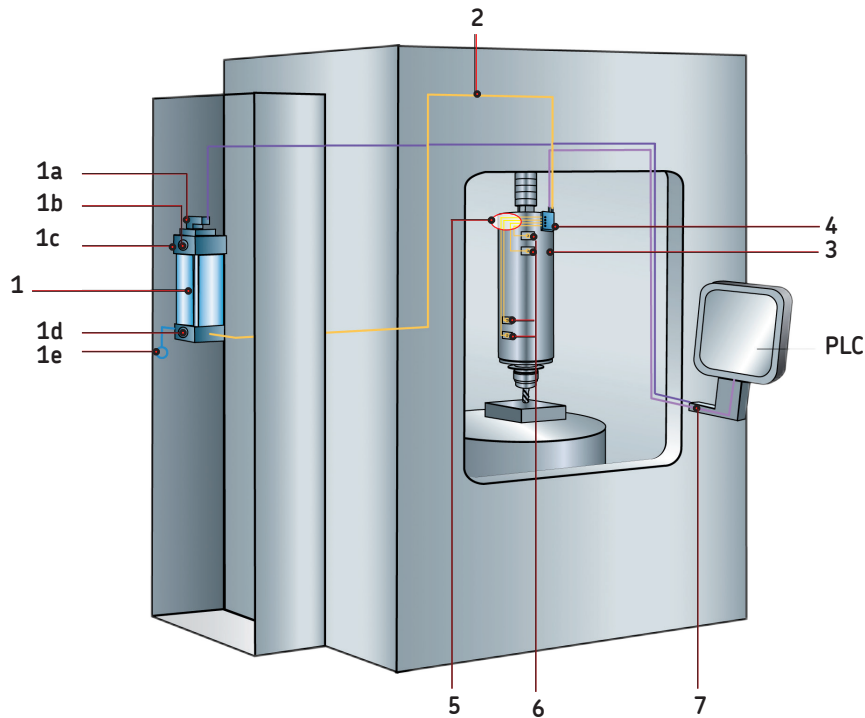

		Legend
Item	Description	Chapter
1	MDR lubricant reservoir	3.3
1a	Electr. fill level switch	4.3.3
1b	Max. fill level sight glass	3.3
1c	Compressed air connection 4.5-10 bar	
1d	Min. fill level sight glass	3.3
1e	Filler coupling	3.3/4.3.4
2	Main lubricant line for MDU (lubricant pressure 4 bar)	4.5
3	High-speed spindle provided by customer	
4	MDU micro-metering unit to supply up to 4 lubrication points	3.2/4.4
5	Capillary lines to the lubrication points	4.4.3/4.4.4
6	Lubrication points (spindle bearing)	OI/Chap. 4
7	Data lines for MDU/MDR for customer's machine tool control unit	OI/Chap. 5

(OI = Operating Instructions)

3.2 Overview of MDU micro-metering unit

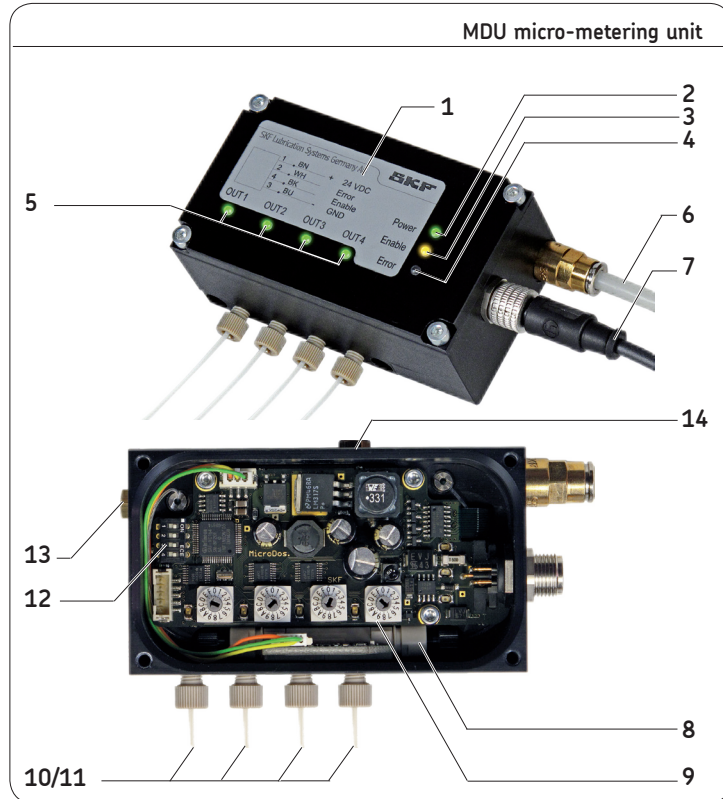

Components of the MDU micro-metering unit

Item	Description	Chapter
1	MDU micro-metering unit	4.4
2	Power supply LED (green power LED)	OI/Chap. 6
3	LED enable signal (yellow enable LED)	
4	Error notification LED (red error LED)	
5	LEDs for outlet 1 to outlet 4 (OUT1- OUT4)	
6	Push connector/connecting cable for lubricant feed	4.4.
7	Connection for supply/control voltage	4.33
8	Flow sensor	OI/5
9	Rotary switch for setting lubricant quantity (x4)	OI/6.2
10	Connection for capillary lines, lubricant outlet (x4) OUT1 to OUT4	4.4.3
11	Capillary lines (x 4)	4.3.4
12	DIP switches for system configuration	OI/6.2.1
13	Side vent plug	OI/6.3.1
14	Top vent plug	OI/6.3.1

(OI = Operating Instructions)

3.3 Overview of MDR lubricant reservoir designs

Examples of various connectivity options,
area of inlet/outlet/filling



The inlets and outlets on the lubricant reservoir can be located on the left or right, and their position can be switched according to need and the installation space.

MDR lubricant reservoir



Components of an MDR lubricant reservoir

Item	Description	Chapter
1	MDR lubricant reservoir	4.3.1
2	Vent plug	4.3.4
3	Electrical fill level monitoring	4.3.3
4	Compressed air control valve	4.3
5	Compressed air input port	4.3.5
6	Pressure gauge for compressed air	4.3.5
7	Assembly holes (4x)	4.3.1
8	Sight glass, visual fill level monitoring, max. fill level	4.3.3
9	Lubricant outlet port (to the MDU)	4.2
10	Lubricant outlet stopcock	4.3.3
11	Sight glass, visual fill level monitoring, min. fill level	4.3.3
12	Pressure regulating valve	4.3.1
13	Filler coupling	4.3.1

4. Assembly

4.1 General information

Only qualified technical personnel may install, operate, maintain, and repair the micro-metering products described in the assembly instructions. Qualified technical personnel are persons who have been trained, assigned, and instructed by the operator of the final product into which the described microdosage system is incorporated. Such persons are familiar with the relevant standards, rules, accident prevention regulations, and operating conditions as a result of their training, experience, and instruction. They are authorized to carry out the required activities and in doing so recognize and avoid potential hazards.

The definition of trained personnel and the prohibition of employing non-qualified personnel are laid down in DIN VDE 0105 and IEC 364.

Before assembling/setting up the micro-metering products, the packaging material and any shipping braces (e.g., plugs) must be removed. The packaging material must be preserved until any discrepancies are resolved.

**Note!**

Do not tilt or drop the MDR lubricant reservoir.

During all assembly work on machinery, observe the local accident prevention regulations as well as the applicable operating and maintenance specifications.

**Note!**

The MDR lubricant reservoir, MDU micro-metering unit, and the entire MDS system must be vented carefully.

A feature of the MDS microdosage system is its ease of use. However, careful commissioning is required for reliable operation. After the system has been configured and put into operation, the only necessary actions are routine checks and any adjustments that may be necessary.

Careful venting of the system is a very important point of the commissioning. Small air

pockets can strongly affect the exact metered quantity.

For correct commissioning, the MDR lubricant reservoir, the MDU unit, and the main lubricant line must be free of any air. Utmost cleanliness must be maintained while installing and commissioning the MDS system. The oils used must be filtered; prescribed filter rating $\leq 5\mu\text{m}$.

The microdosage system should be assembled and commissioned according to the following sequence:

MDR lubricant reservoir(Chapter 4.3)

- Attachment of MDR lubricant reservoir
- o Install the lubricant reservoir
 - o Electrical connection, fill level control
 - o Initial filling and venting
 - o Connect compressed air connection

MDU micro-metering unit (Chapter 4.4)

Attachment of the micro-metering unit

- o Electrical connection
- o Capillary line connection
- o Arrangement of capillary lines/
connection of lubrication points

Main lubricant line and venting (Chapter 4.5)

Information on preparing the bearings is contained in Chapter 5 of the enclosed operating instructions.

See also the setting options for the microdosage system in Chapter 6.

4.2 Setup and attachment



Note

Absolute cleanliness is required when connecting the MDR, the MDU, the main lubricant line, and the capillary lines. Ensure that no dust particles enter the metering system.



Consult these assembly and operating instructions for the technical data for the MDR lubricant reservoir and the MDU micro-metering unit.

These documents can also be downloaded from the homepage of SKF Lubrication Systems Germany GmbH.

The MDU micro-metering unit and the MDR lubricant reservoir system should be protected from humidity and mounted in a low-vibration and easily accessible position, allowing all further installation work to be done without difficulty.

Ensure that there is sufficient air circulation to prevent excessive heating. For the maximum permissible ambient temperature, see "Technical data."

Ensure adequate space for refilling the lubricant reservoir (manual refilling).

4.2.1 General information on lubrication line arrangement



Warning!

Lubrication lines must always be free of leaks. Lubricants can contaminate soil and waterways. Lubricants must be used and disposed of properly. Observe the local regulations and laws regarding the disposal of lubricants.



Danger!

Centralized lubrication systems must always be free of leaks. Leaking lubricant is hazardous due to the risk of slipping and injury. Beware of any lubricant leaking out during assembly, operation, maintenance, or repair of centralized lubrication systems. Leaks must be sealed off without delay.



Follow the safety instructions on the lubricant's safety data sheet.

4.3 MDR lubricant reservoir

The lubricant reservoir should be installed in a freely accessible area to allow for manual filling and visibility of both sight glasses (fill level minimum and fill level maximum).

It must be ensured that there is still enough clearance above the reservoir for venting and connection of the electrical fill level switch.

The lubricant reservoir is mounted in a vertical position, with the connection for lubrication lines and filler nozzle located in the lower part of the reservoir. The lubricant outlet and filler coupling can be interchanged.



Danger!

The pressure regulating valve on the side of the reservoir is non-adjustable and cannot be modified or removed.

The compressed air supply to be connected generates priming pressure for the lubricant.

Lubricant and compressed air are separated from each other by a dividing piston, so a compressed air filter is not required. Any assembly holes must be made according to the diagram on the following page.

During assembly and especially when drilling, always pay attention to the following:

- o Maintain safety clearances and comply with local regulations for assembly and accident prevention.
- o The MDR lubricant reservoir may only be installed vertically.
- o The MDR lubricant reservoir must be installed an adequate distance from sources of heat.
- o Existing supply lines must not be damaged by assembly work.

- o Other units must not be damaged by assembly work.
- o The MDR lubricant reservoir must not be installed within range of moving parts.

Contents of the supplied accessories kit:

- o Hexagon head screws (4x) acc. to ISO 4014-M8x130-8.8
- o Washers (4x) acc. to ISO 7090- 8-200-HV
- o Hexagon nuts (4x) acc. to ISO 4032-M8-8
- o Two-tube socket wrench WAF 10x13
- o Vent hose, transparent and highly flexible, 60 cm long

4.3.1 Attachment of MDR lubricant reservoir

☞ See Figure 1

Installing the lubricant reservoir

- Drill assembly holes (\varnothing 9 mm, 4x) (1) on the surface provided by the customer according to the assembly drawing.
- Clean the surface to remove drilling chips; prime the boreholes if necessary.
- Pass hexagon head screws (4x) with associated washers through the fixing holes on the customer's installation position/ mounting plate.
- Apply hexagon nuts (4x) with associated washers and tighten gently; align the MDR horizontally and vertically.
- Tighten hexagon head screws.

4.3.2 Assembly drawing with minimum installation dimensions

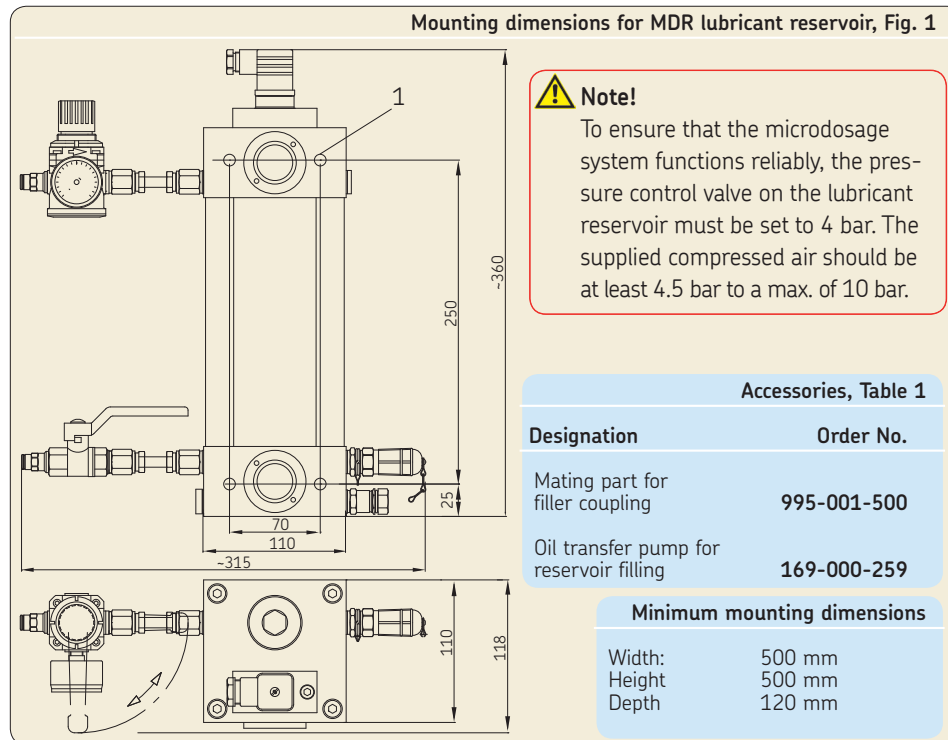

4.3.3 Electrical fill level indicator

☞ See Figure 2

- Connect the electrical fill level switch (1) according to Figure 7

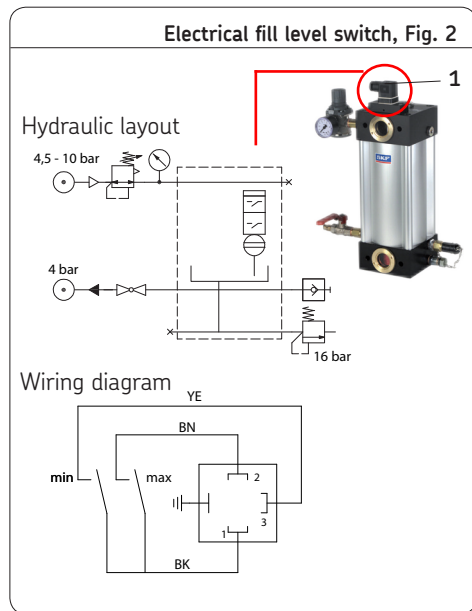

4.3.4 Initial filling and venting of the MDR lubricant reservoir

☞ See Figure 3

To ensure that the micro-metering unit functions properly, the pressurized lubricant reservoir must be vented.



Note
The lubricant reservoir must not be under compressed air during filling. There must not be any compressed air connection between the reservoir and the compressed air supply.

- Shut off the compressed air feed (1), if connected.
- Close the lubricant stopcock (10).
- Remove the screw plug (2) with the supplied socket wrench (3) (WAF 17) so that existing pressure can release.
- Remove the screw plug (2).
- Remove the cap (4) of the filler coupling (5).

- Connect the filling device (e.g., hand pump) (6) and fill up to the start of the maximum level on the sight glass (7).

- Draw the vent hose (8) (internal diameter 4-5 mm) through the socket wrench (3) (DIN 896, Form B 10x13).

- Place vent hose (8) and socket wrench (3) on the vent plug (9) (WAF 10).

- Apply open-end wrench (WAF 7) (10) to the socket wrench (3) and loosen a vent plug (9) three-quarters of a rotation.

- Actuate filling device (6) until bubble-free oil discharges from the vent hose (8).

- Tighten vent plug (9).

☞ To prevent the oil from flowing back into the inside of the reservoir, clamp/close the vent hose above the level of the socket wrench.

- Clamp/close the vent hose above the level of the socket wrench.
- Pull off and remove vent hose (9) and socket wrench (3).
- Apply hexagon socket screw (2) and tighten with socket wrench (3) (torque 5 Nm).
- Continue filling until the lubricant has reached the upper third of the maximum level on the sight glass (7).
- Remove filling device (6) and install cap (4).
- Switch on the compressed air supply.

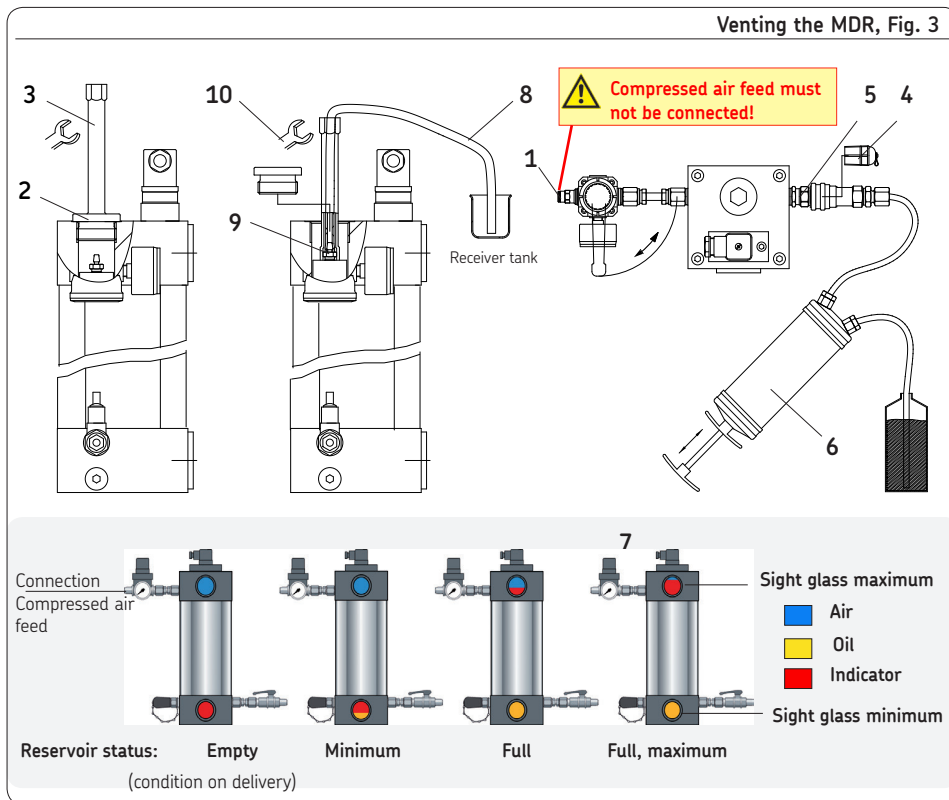

4.3.5 Connecting compressed air connection

☞ See Figure 4

The compressed air connection on the MDR lubricant reservoir comes standard with an SKF plug connector for a 6 mm tube. The compressed air line (provided by customer) is connected as described below.

The SKF plug connector attached to the compressed air connection of the lubricant reservoir is designed for plastic tubing. A locking claw on the collet secures the plastic tube in the plug connector, which prevents the tube from accidentally slipping out.

- Cut the plastic tube (1) straight using a suitable tube cutter (see Chapter 12, Accessories).

☞ In the following installation of the plastic tube, a noticeable resistance must be overcome when passing through the first O-ring (2), the locking claw (5) of the collet (4).

- Use one hand to manually insert the plastic tube (1) fully into the collet (4) of the plug connector until it clears the first O-ring (2) and the locking claw (5) of the collet (4) and reaches the mechanical stop (3).

To remove the plastic tube (1), press the collet (4) inward into the plug connector. To do this, also press the plastic tube (1) inward into the plug connector fitting, which releases the collet (4) from the plastic tube (1). The plastic tube (1) can now be pulled out of the collet (4) of the plug connector.

Before reassembling, shorten the end of the plastic tube by at least 7 mm to ensure that the locking claw of the collet functions properly.

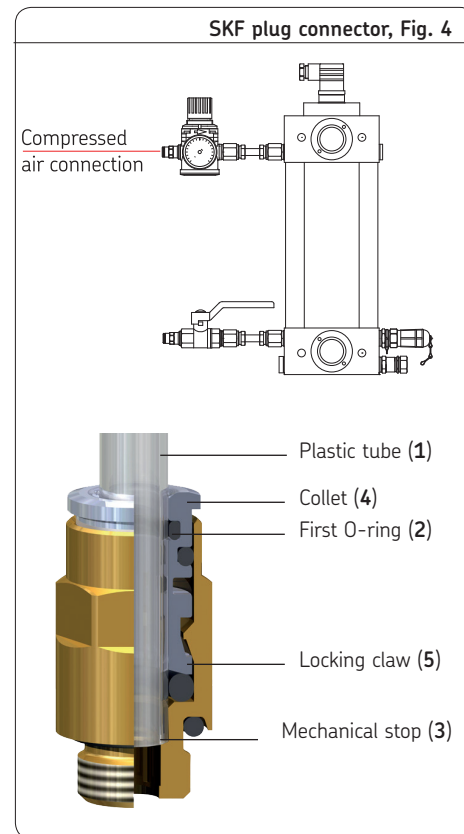

4.4 MDU micro-metering unit

☞ See Figure 5

The MDU should be installed in a freely accessible area so that subsequent adjustments can be made and to ensure good visibility for the LEDs.

The MDU can be mounted in any position. SKF recommends installing the micro-metering unit in such a way that the capillary line connections point in the direction of the lubrication points and are as short as possible (max. length of 4 m).

Due to its protection class of IP67, the MDU cannot be mounted on the spindle/spindle's working area. Any cooling lubricant that discharges does not impair function.

Any assembly holes must be made according to the Figure 5 below.

During assembly and especially when drilling, always pay attention to the following:

- o Existing supply lines must not be damaged by assembly work.
- o Other units must not be damaged by assembly work.
- o The MDU micro-metering unit must not be installed within range of moving parts.
- o The MDU micro-metering unit must be installed an adequate distance from sources of heat.
- o Maintain safety clearances and comply with local regulations for assembly and accident prevention.

To ensure enough space for maintenance work and for possible disassembly of the SKF microdosage system, ensure that the minimum mounting dimensions (Fig. 5 and Fig. 6) are maintained.

4.4.1 Attachment of the MDU micro-metering unit

☞ See Figures 5 and 6

Attachment of the micro-metering unit

- Drill assembly holes (\emptyset 6 mm) (1) on the surface provided by the customer according to the assembly drawing (Fig. 5).
- Clean surface to remove drilling chips; prime the boreholes if necessary.
- Pass hexagon head screws (2x) with washers through the fixing holes on the mounting position/mounting plate.
- Apply hexagon nuts (2x) with washers on the MDU and tighten gently; align the MDU horizontally and vertically.
- Tighten hexagon head screws.

Electrical connection

- Place plug and socket coupling (M12x1) onto the connector plug (2) of the MDU, then align and tighten by hand.

4.4.2 Assembly drawing with minimum installation dimensions

Assembly drawing of the MDU micro-metering unit, Fig. 5

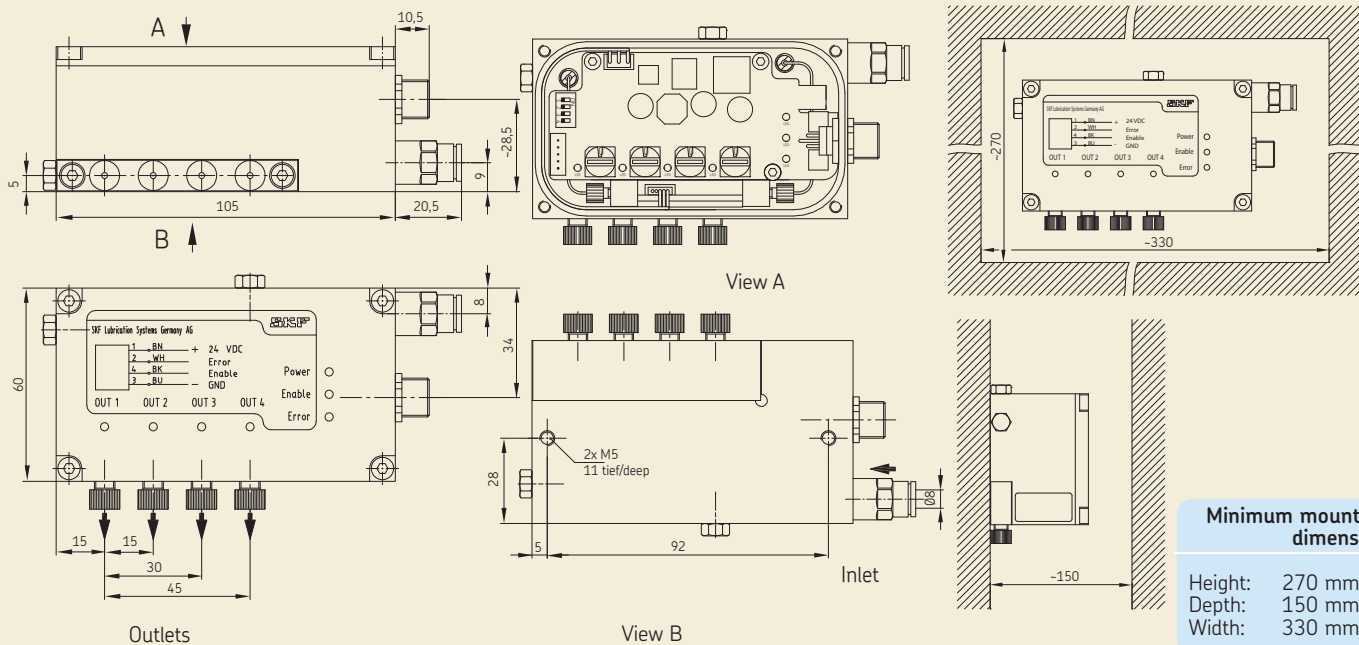

Minimum mounting dimensions	
Height:	270 mm
Depth:	150 mm
Width:	330 mm

Electrical connection, Fig. 6

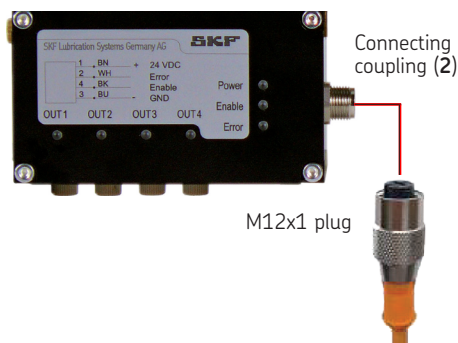

M12x1 plug

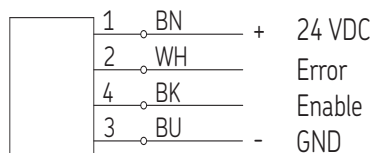

Enable: 0 / 24 V

Error: 0 = error/ 24 V = OK

**Note!**

Use functional extra-low voltage with safe isolation according to standard DIN EN 60204-1 / IEC/60204-1.

When establishing the MDU micro-metering unit's electrical connection, ensure that appropriate measures prevent interference between signals due to inductive, capacitive, or electro-magnetic couplings.

Shielded cables must be used if electrical interference fields affect signal transmissions despite separate laying of cables. Ensure that cables are arranged in an "EMC-compliant" manner.

Accessories, Table 2

Designation	Order No.
4-pin plug, M12x1 with 5 m connection cable	179-990-600
4-pin plug, M12x1 (without connecting cable)	179-990-371

Note!

You can find additional technical data on the cable sockets in the brochure "Electrical Plug and Socket Connectors," brochure No. 1-1730-EN.

4.4.3 Capillary line connection

☞ See Figure 7

The capillary line is not included with the MDU and must be ordered separately as an accessory (see “Accessories” chapter). The capillary line must be trimmed to size using a special hose cutter which can be ordered separately.

☞ The interfaces at the ends of the capillary lines must be clean for the system to function properly.

- Draw capillary line (9) through the union nut (5) and clamp ring (7) and place it flush on the ferrule (8) (sleeve).
- Apply union nut (5) (with capillary line, clamp ring, and ferrule) to the capillary union on (6) and tighten.
- Check whether the hose is correctly installed; briefly pull on the end of the hose (capillary union) to do so.

☞ The lubricant feed line must not escape from the plug connector.

- Repeat the procedure for the remaining capillary unions.

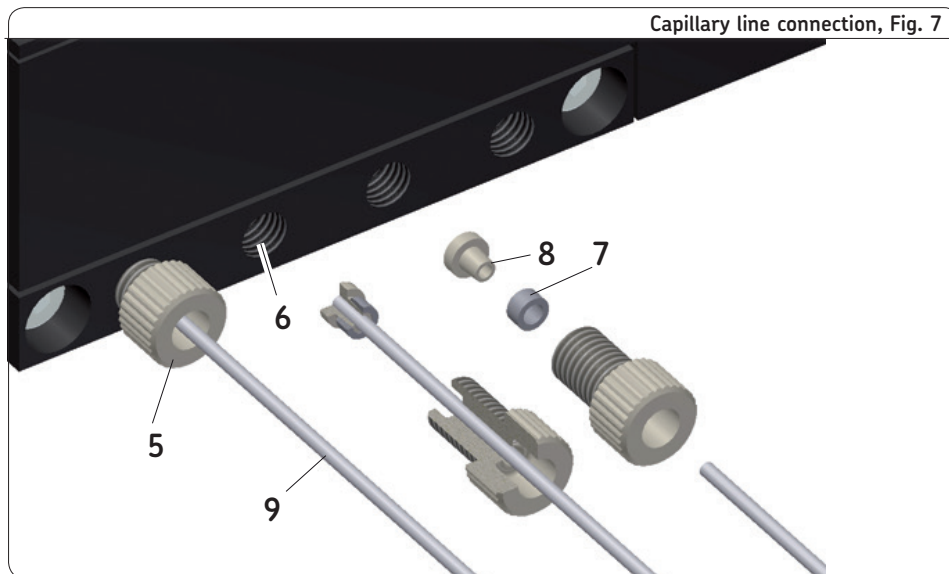

4.4.4 Arrangement of capillary lines

☞ The plastic capillary lines must have an internal diameter of 0.5 mm and cannot be longer than 4 m each.

- Arrange capillary line (9) to the lubrication point.

Observe the following when arranging the lines:

- o Arrange lines so that they are protected against contamination, environmental influences, and damage.
- o Arrange lines as short as possible and without any kinks.
- o Use large bending radii.
- o The capillary lines should lie close to the machine tool.
- o Avoid laying over moving parts.

4.5 Main lubricant line and venting

☞ See Figure 8

The main lubrication line connecting the MDU metering unit to the MDR lubricant reservoir must be connected to the metering unit in such a way that no forces can be transferred to it once assembled (stress-free connection). SKF recommends using a main lubricant line made of transparent plastic so that the lubricant flow and absence of bubbles can be assessed visually during commissioning. During operation, however, the lubricant flow is not visible.

By default, the connection for the main lubrication line on the MDR is equipped with an SKF plug connector. The main lubricant line/plug connector is connected as described above under "Connecting compressed air connection".

- Arrange main lubricant line (\varnothing 6 mm) from the SKF plug connector to the MDR lubricant reservoir.

- Arrange the main lubricant line without any kinks using appropriate fastening materials.
- Connect main lubricant line to SKF plug connector.

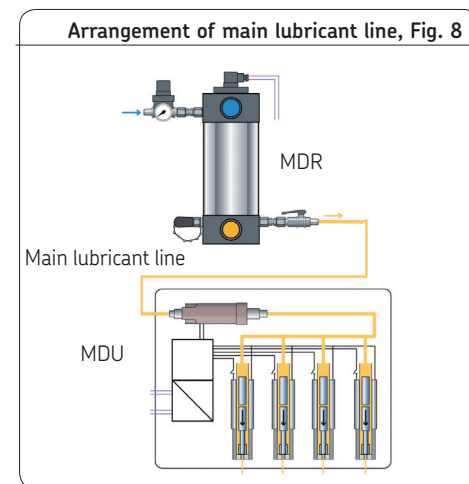

4.5.1 Venting the main lubricant line and MDU micro-metering unit

☞ See Figure 9

Requirements:

- o The MDR lubricant reservoir is completely connected and has already been vented (see Chapter 4.3.4).
- o The main lubricant line (1) has already been arranged from the MDR lubricant reservoir to the MDU micro-metering unit (see Chapter 4.5).



Note!

The main lubricant line is only connected to the MDR lubricant reservoir, not to the MDU.

- o The capillary lines are connected to the MDU micro-metering unit (see Chapter 4.4.3).
- o The MDU micro-metering unit must be closed and ready for operation.

- o Place the oil pan under the MDU, extend the loose end of the main lubricant line (connection to MDU) into the pan.

Venting procedure for main lubricant line

- Apply compressed air (2) to the MDR reservoir.
- Set the pressure control valve (3) to 4 bar.
- ☞ The MDU can be mounted in any position, so the highest vent plug (vent plug (4) or (5)) should be used.
- Loosen and unscrew MDU vent plugs ((4) or (5)).
- Slowly open the MDR stopcock (6) so that oil can enter the line in a controller manner.
- If bubble-free lubricant discharges at the end of the loose main lubricant line (1),

immediately attach the loose end of the lubricant line to the plug connector of the MDU (7).

Venting procedure for MDU

- ☞ The main lubricant line must not escape from the plug connector.
- Check whether the hose is correctly installed; briefly pull on the end of the main line to do so.
- ☞ Due to the integrated oil microfilter within the MDU and to the system's oil duct design, the following venting procedure may take more than 5 minutes.. The venting procedure can only be completed once bubble-free oil discharges from the venting bore.
- Close the venting bore with the vent plug ((4) or (5)) as soon as bubble-free oil

discharges from the bore.

- ☞ The initial oil discharge has a red coloring. This is testing oil what was used in the factory inspection of the MDU.
- Use an absorbent cloth to remove discharged oil; remove oil residues using a cloth.

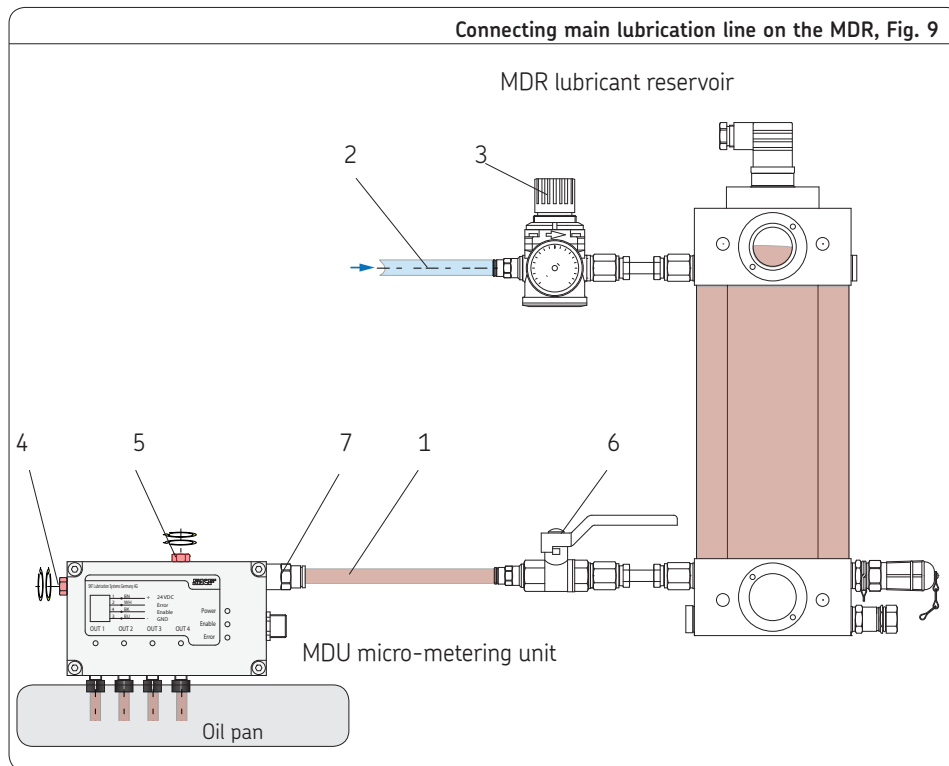

4.6 Note on the rating plate

The rating plate of the MDU micro-metering unit and the MDR lubricant reservoir provides important key data such as type designation and serial number (or customer number). To avoid loss of this data in case a rating plate becomes illegible, these characteristics should be entered in the following table.

- Enter key data from rating plate in the following table.

4.6.1 MDU rating plate

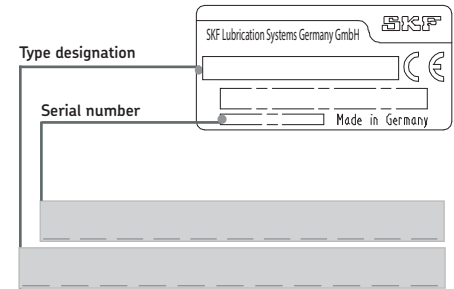

4.6.2 MDR rating plate

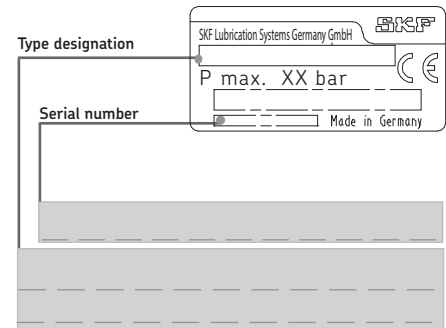

Microdosage system (MDS)

for continuous lubrication of high-speed spindles
with minimum quantities of oil from 0.5 to 5 mm³/min

**Operating instructions associated
with assembly instructions**

1. Safety instructions

1.1 General information



The operator of the described product must ensure that the operating instructions are read and understood by all persons tasked with the assembly, operation, maintenance, and repair of the product.

In addition to the operating instructions, general statutory regulations and other regulations for accident prevention and environmental protection must be observed and applied.

1.2 Disclaimer of liability

SKF Lubrication Systems Germany GmbH shall not be responsible for damages:

- o Caused by contaminated or unsuitable lubricants
- o Caused by the installation of non-original SKF components or SKF spare parts
- o Caused by inappropriate usage
- o Resulting from improper assembly, configuration, or filling
- o Resulting from improper response to malfunctions
- o Caused by independent modification of system components
- o Only media approved for these types of units may be used. Unsuitable media may result in pump unit failure and potentially severe bodily injury and property damage.



Note!

The information on lubricants listed in Chapter 2, "Lubricants," of the assembly instructions also applies without restrictions to these operating instructions.

2. Lubricants

3. Transport, delivery, and storage

SKF Lubrication Systems Germany GmbH products are packaged in accordance with standard commercial practice according to the regulations of the recipient's country and DIN ISO 9001. During transport, safe handling must be ensured and the product must be protected from mechanical effects such as impacts. The transport packaging must be marked "Do not drop!"



Note!

Do not tilt or drop the product.

There are no restrictions for land, air, or sea transport.

After receipt of the shipment, the product(s) must be inspected for damage and for completeness according to the shipping documents. Keep the packaging material until any discrepancies have been resolved.

SKF Lubrication Systems Germany GmbH products are subject to the following storage conditions:

3.1 Lubrication units

- o Ambient conditions: dry and dust-free surroundings, storage in well ventilated dry area
- o Storage time: Max. 24 months
- o Permissible humidity: < 65%
- o Storage temperature: + 10 to +40°C
- o Light: Avoid direct sun or UV exposure and shield nearby sources of heat

3.2 Electronic and electrical devices

- o Ambient conditions: dry and dust-free surroundings, storage in well ventilated dry area
- o Storage time: Max. 24 months
- o Permissible humidity: < 65%
- o Storage temperature: +10 to 40°C
- o Light: Avoid direct sun or UV exposure and shield nearby sources of heat

3.3 General information on storage

- o The product(s) can be enveloped in plastic film to provide low-dust storage.
- o Protect against ground moisture by storing on a shelf or wooden pallet.
- o Bright-finished metallic surfaces, especially wearing parts and assembly surfaces, must be protected using long-term anti-corrosive agents before storage.
- o At approx. 6-month intervals: Check for corrosion. If there are signs of corrosion, reapply anti-corrosive agents.
- o Drives must be protected from mechanical damage.

4. Assembly

4.1 Information on assembly

The assembly procedure for the SKF microdosage system is described in detail in the assembly instructions (Chapter 4) associated with these operating instructions.

4.2 Installation and use on spindles

General

The microdosage system can be used for continuous and highly accurate metering of small quantities of lubricant.

The following points must be observed when designing the spindles and selecting the bearings so that the extremely small quantities of lubricant can reliably reach the lubrication points.

4.2.1 Spindle design

☞ See Figures 1 to 3

The microdosage system and its lubricant outlets were designed for capillary lines with an outside diameter of 1/16 inches and an internal diameter of 0.5 mm.

The tube threads indicated in Figure 1 are suitable for connecting the capillary lines on the spindle and bearing.

The capillary lines are connected similar to the capillary lines on the microdosage unit (see page 28, Fig. 7).

The required connector systems (socket unions, ferrules, clamp rings) can be ordered separately as accessories (see Chapter 11). The maximum length of capillary lines between an outlet on the micro-metering unit and the lubrication point is 4 meters.

Connection versions on the spindle side, Fig. 1

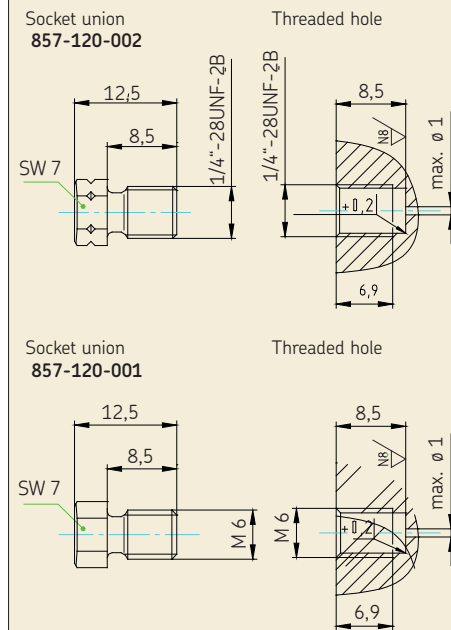

The lubricant ducts inside a spindle and to the bearing lubrication points should meet the following criteria:

- o As short as possible
- o Diameter of 0.5 mm to max. 1.0 mm

The way the lubricant is fed to the bearing depends on the bearing type and the bearing assembly's design features. Figures 2 to 4 below provide examples of the lubricant feeding. In case of single-row rolling bearings, it is possible for the lubricant to be introduced into the rolling bearing from the side. To do so, a needle with an internal diameter of approx. 0.5 mm should be introduced as deep as possible into the rolling bearing at the level of the its inner ring. This penetrates the air vortex generated by high-speed bearings and reduces the impact on lubricant distribution. If using rolling bearings that exert pumping force in one direction (e.g. angular contact bearings), the lubricant must be fed in the direction of pull. In case of double-row cylindrical

roller bearings, the lubricant should be introduced into the rolling bearing from both sides at the level of the outer ring raceway. It is also possible to feed the lubricant via a borehole on the rolling bearing's running surface located in the bearing's outer ring (see Figure 3). In this case, it must be assured that the lubricant is not introduced into the pressure zone of the rolling bearing between the rolling element and the bearing ring. There must be only one borehole in the outer ring if the lubricant is fed via a borehole in the outer ring and the outer ring is equipped with a groove through which the lubricant reaches the borehole.

Additionally, the groove must be completely primed during installation. Further boreholes would lead to drainage of the lubricant-filled outer ring groove, which could result in insufficient lubrication of the bearing.

Lubricant feeding for vertical and horizontal mounting position and rotating inner ring, Fig. 2

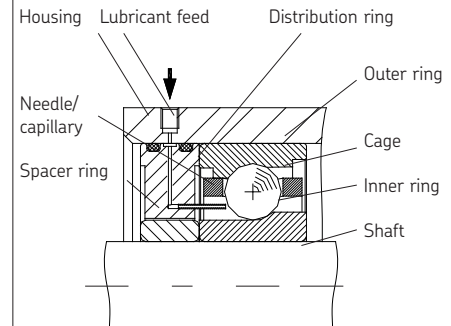

! Observe the instructions from the bearing manufacturer regarding the bearings to be used; consult with the bearing manufacturer if necessary.

Lubricant feeding via outer ring, Fig. 3

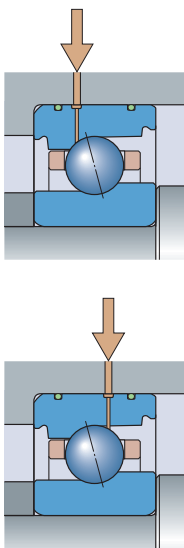

4.2.2 Lubricant quantity

The amount of lubricant required to lubricate a bearing depends on the type of bearing, number of rows, width, etc. In principle, the bearing manufacturer should be contacted when determining the quantity of lubricant for a bearing. Guidelines for the quantities of oil to be supplied to each bearing of high speed operation can be obtained from:

$$Q = 1.3 \times d_m$$

- Q = Oilflow [mm³/h]
- d_m = bearing mean diameter
= 0.5 (d+D) mm
- d = Inner ring diameter
- D = Outer ring diameter

The calculated oil flow rate should be verified during operation and adjusted, depending on the resulting temperatures.

Lubrication of bearing running surfaces with the microdosage system is more efficient compared to oil+air lubrication. Almost 100% of the required lubricant reaches the lubrication points continuously and as defined. In contrast, in oil+air lubrication not all of the lubricant is used effectively.

For these reasons, it is expected that the amount of lubricant required when using a Microdosage system falls lower than when using an oil-air lubrication.

4.2.3 Filling lubricant ducts in the spindle

Within the spindle, there are lubricant ducts through which the lubricant is transported from the connecting points on the spindle to the bearing lubrication points.

The ducts have a volume which must be filled during commissioning, comparable to the filling of capillary lines.

Two variables must be known in order to fill precisely.

1. The volume of the lubricant ducts
2. The lubricant volume per minute in the MDS's filling mode

1. The length and diameter of the lubricant ducts depend on the spindle design and are typically different for each bearing lubrication point. Information on the exact volumes can be obtained from the spindle manufacturer.

2. The volumetric flow provided by the micro-dosage system in filling mode depends on the viscosity and consequently on the ambient temperature. It is between 100 and 200 mm³/min. The exact value can be determined during the filling procedure for the capillary lines (see Chapter 6.3.1).

This involves measuring the time required by the volumetric oil flow in filling mode to fill one meter (for example) of the capillary line (1 m \pm 200 mm³ with internal diameter = 0.5 mm).

The filling time is as follows:

$$FT = DV / FQ \text{ [s]}$$

FT: Filling time for duct in s

DV: Volume of lubricant duct in mm³

FQ: Volumetric flow of the MDF in filling mode in mm³/min

If the volumetric oil flow in filling mode is not available or only very small volumes are to be filled, a defined quantity of lubricant can also be set using the rotary switches (SV) on the MDS, for example 5 mm³/min.

The filling time is as follows:

$$FT = DV / SF \text{ [s]}$$

FT: Filling time for duct in s

DV: Volume of lubricant duct in mm³

SF: Set volume on MDS in mm³/min

5. Design and function

5.1 General information

☞ See Figure 4

The SKF microdosage system is an intelligent micro-metering system for especially demanding applications. It feeds lubricant to the lubrication point in a nearly continuous volumetric flow in the μl range and, in contrast with conventional lubrication systems, does not require any compressed air to transport the lubricant. This makes it especially energy-efficient and accurate.

The SKF microdosage system consists of two components, the micro-metering unit (MDU) and the lubricant reservoir (MDR).

The two-part design of the system makes it possible to install the micro-metering unit and the lubricant reservoir in physically separate locations.

The highly compact micro-metering unit can be operated immediately adjacent to the lubrication point, for example on the machine tool spindle, while the relatively larger lubricant reservoir can be placed at a greater distance (see Figure 1).

The system's components perform the following tasks:

MDR lubricant reservoir (1)

- o Storing lubricant
- o Generating priming pressure for the lubricant
- o Separating media between lubricant and compressed air
- o Monitoring the lubricant supply
- o Reporting fill level to the machine tool's control unit

MDU micro-metering unit (3)

- o Providing 4 individually adjustable lubricant outlets (8)
- o Generating nearly continuous volumetric flows
- o Controlling and monitoring volumetric flows
- o Calibrating lubricant quantities
- o Communicating with the machine tool's control unit via enable and error signals

The system components are connected via the main lubricant line (3).

In the micro-metering unit, the lubricant is routed through microvalves (7) that generate a quasi-continuous volumetric flow.

A highly sophisticated control unit (5) uses a flow sensor (4) to monitor the specified volumetric flows, calibrates the system upon defined events, and reports any errors that occur.

Numerous adjustment options allow for the lubrication system to be finely adjusted to the particular lubrication task at hand.

5.2 Principle of the SKF microdosage system

☞ See Figure 4

The SKF microdosage system consists of two main components, the lubricant reservoir (**MDR**) and the micro-metering unit (**MDU**).

When the system is activated, pressure is applied that presses the follower piston in the lubricant reservoir (**1**) onto the quantity of oil in the reservoir. The lubricant (oil) primed at 4 bar then flows through the connected main lubrication line (**2**) and into the inlet of the MDU micro-metering unit (**3**). From there, it passes through a flow sensor (**4**) and a feed duct with venting capability (**6**) to the four micro-metering valves (**7**).

In quick succession, the four micro-metering valves (**7**) are actuated successively, which creates in the connected capillary lines (**8**) a nearly continuous volumetric flow of lubricant to the respective lubrication point.

The flow sensor (**4**) constantly monitors the flow of lubricant through each valve. The lu-

bricant flow at the respective outlet is checked for adherence the defined tolerances according to the settings.

The MDU micro-metering unit has a calibration function that can be activated manually or automatically. Manual activation is performed separately for each valve via the assigned rotary switch (Chap. 6.2.3- Determining quantity of lubricant).

Automatic calibration starts for all active lubricant outlets during lubrication operation and is event-driven (see Table 1).

While the MDU performs metering, the flow sensor (**4**) monitors the volumetric flow at each outlet. If enabled, the automatic calibration mode (table A, S4 = off) starts in the event of deviations from the set volumetric flow. If the calibration cannot compensate for deviations in the volumetric flow, an error signal is generated at the error output of the MDU and can be evaluated by the customer's

PLC or machine control unit. The MDU continues metering option despite limitations and attempts to resolve the error. The error signal is reset if the error is resolved.

Switching off the operating voltage to the MDU resets the error signal. If the MDU is re-activated when an error is present, the error is quickly detected and an error signal is generated.

Deviations in the metered volumetric flow can have various causes:

- o No lubricant available
- o Priming pressure absent or too low/too high
- o Air bubbles in the system

- o Clogged line to the lubrication point
- o Deviations from the operating temperature range
- o Error in a metering valve
- o Error in the flow sensor

The MDU only generates an error signal if the presence of an error has been confirmed by repeated checks.

The cause of the error is indicated by the blinking pattern of the LEDs on the MDU (see Chapter 9.2, Table 2).

Automatic calibration, Table 1

Event	Parameter
Delay between switching on and 1st calibration	1 min
Calibration interval	4 h
Calibration at temperature change	5 Kelvin

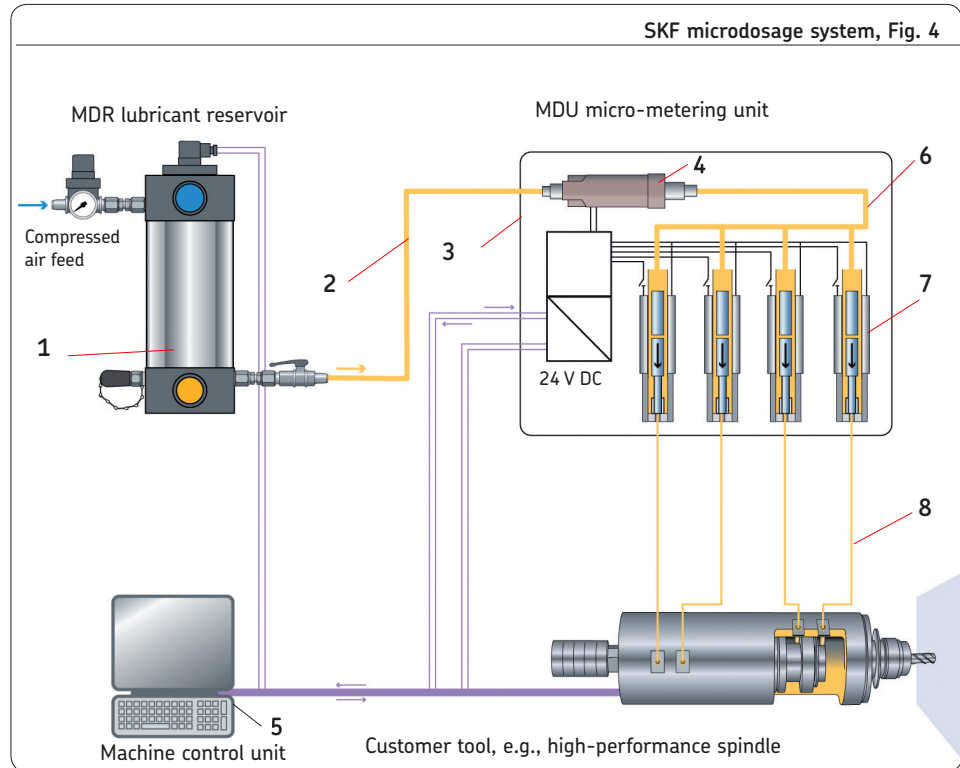

6. Operation

6.1 General information

The fill level of the lubricant in the lubricant reservoir should be subjected to visual inspection at regular intervals. If the lubricant fill level is too low, lubricant needs to be added up to the maximum mark as described in Chapter 4.4.5 "Commissioning and venting the MDR."

 Observe the instructions from the machine manufacturer regarding the lubricants that are to be used.

 The MDU is subjected to an inspection and adjustment using colored lubricant at the factory.
A residual amount of lubricant does not impair function.



Note!

Only fill using clean lubricant and an appropriate device. Contaminated lubricants can result in severe system malfunction. The lubricant reservoir must be filled without introducing bubbles.

6.2 Microdosage system parameters

MDU adjustment elements, Fig. 5

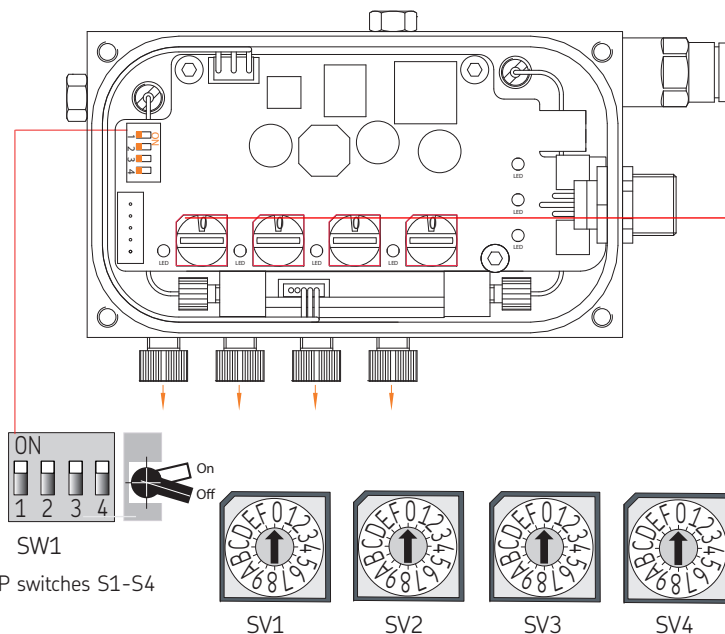

SW1
DIP switches S1-S4

Rotary switches SV1 to SV4 = lubrication point 1 to lubrication point 4

Legend to Fig. 5

WAF 1 DIP switches S1 to S4 (description in Chapter 4.5.1, adjusting table A)

System configuration

S1	Quantity reduction of 1:10
S1 off	Volumetric flow 0.5 to 5.0 $\mu\text{l}/\text{min}$
S1 on	Volumetric flow 0.05 to 0.5 $\mu\text{l}/\text{min}$
S2	No function (reserved)
S3	Enable type (start/stop of outlets)
S3 off	Enable via HIGH level (+24 VDC)
S3 on	Enable via LOW level (0 VDC, GND)
S4	Calibration mode
S4 off	Automatic calibration during lubrication operation
S4 on	No automatic calibration

Rotary switches SV1 to SV4 (description in Chapter 6.2.3, adjusting table B)

- o Setting for volumetric flow required for outlets 1 to 4
- o Deactivation of outlets 1 to 4
- o Venting and line-filling mode
- o Manual calibration of the particular lubricant outlet

6.2.1 Configuring the system

Table A

Function/operating mode (S1 to S4)	Switch position			
	[S1]	[S2] ¹⁾	[S3]	[S4]
Condition on delivery/default setting				
Time slot				
S1 off = Volumetric flow range 0.5 to 5.0 µl				
S1 on = Volumetric flow range 0.05 to 0.50 µl				
Delivery signal status				
S3 off = lubrication at high signal (24 VDC)				
S3 on = lubrication at low signal (GND, 0 VDC)				
Calibration				
S4 off = automatic calibration				
S4 on = no automatic calibration				

1) S2 has no function (reserved for future firmware update)

6.2.2 Determining quantity of lubricant

Table B

Configuration of lubricant quantity (SV1 to SV4)		Rotary switch [Switch position]
	µl/min	
Lubrication system deactivated	0	0
Lubricant quantity	0.5	1
	1.0	2
	1.5	3
	2.0	4
	2.5	5
	3.0	6
	3.5	7
	4.0	8
	4.5	9
	5.0	A
Lubrication system deactivated		B
		C
		D
Manual calibration		E
Venting/line filling		F

6.3 Commissioning/venting the system

☞ See Figure 6

A requirement for commissioning is that the MDR lubricant reservoir has been installed, filled, and vented properly according to the assembly instructions. The main lubricant line between the lubricant reservoir (MDR) and metering unit (MDU) must also be installed and filled with oil.

☞ See the assembly instructions:

Chapter 4.5 - Main lubricant line and arrangement

Chapter 4.5.1 - Venting the main lubricant line and the MDU

Chapter 4.3.4 - Initial filling and venting of the MDR lubricant reservoir

- Connect connector plug (1) to MDU metering unit (2).
- Loosen hexagon socket screws (4x) (WAF 3) (3) from the lid (4).

☞ Light guides for the LED display are contained on the inner part of lid of the metering unit. During disassembly/assembly, the lid must therefore be carefully removed, put aside safely, and later put back on precisely.

- Carefully lift the lid with hexagon socket screws and put it aside.
- Switch on the machine/system using an external PLC.

☞ By default, the MDU is configured so that the enable input expects a high signal to enable the system, i.e., to start lubrication operation. If no external enable signal is available during commissioning, the system can be started and stopped by switching DIP switch 3.

☞ The capillary lines must be connected to the system but **not to the lubrication points.**

6.3.1 Venting the system

☞ See Figures 5 and 7

Next, vent the valves and fill the capillary lines.

- o Filling the capillary lines simultaneously vents the valves.
- o The outlets can only be filled/vented successively, i.e., at any time **only one** outlet can be activated for this procedure.
- o The filling procedure is activated by switch position "F".
- o If one outlet is in filling mode, all other outlets pause regardless of the setting selected on the SV switches.
- o If the switches for multiple outlets are in position "F", the filling procedure is performed for the outlet with the smallest number.
- o The filling procedure is stopped by switching the SV to position "0".

- o If the switches for multiple outlets are in position "F", the filling procedure is started for the next outlet with the smallest number immediately after the active outlet is stopped.
 - o A valve is vented if no air pockets are visible in the capillary line.
 - o The filling procedure for the capillary line is complete when bubble-free oil discharges at the end of the line and no air pockets are present in the line.
 - o The filling time for a capillary line is between 30-60 seconds per meter depending on the oil viscosity and temperature.
 - o After a pause of approx. 60 min, it is recommended that the capillary line be checked again for formation of air pockets. This may occur during commissioning if the oil still contains dissolved air that can only discharge and become visible in the non-pressurized capillary line.
- o The filling procedure must be repeated if air pockets occur.
 - o The filling process for the lubricant capillaries must be performed successively for each outlet. Outlet 1 is the recommended starting point, followed by outlets 2, 3, and 4 successively.
 - Leave SV1 (5) in position "F" until bubble-free oil discharges from OUT1 at the end of the capillary line.
 - Turn rotary switch SV1 (5) to position "0".
 - Connect capillary line from valve 1 (SV1 = OUT1) to lubrication point 1.
 - Repeat the venting and filling procedure for the remaining valves (SV2 to SV4) in order.

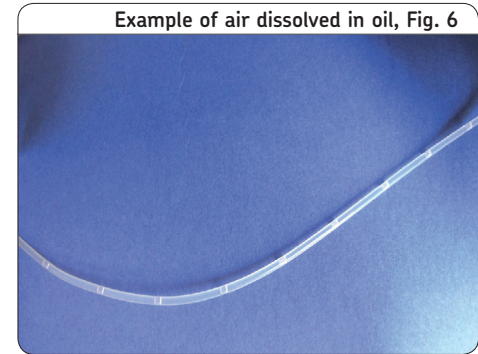

6.3.2 Filling spindle lubricant ducts

☞ See Chapter 4.2.3

To conclude, the lubricant ducts within the spindle are individually filled with lubricant.

The procedure is analogous to filling capillary lines. Filling is activated using switch position “F” for the outlets. With this method, only one duct can be filled successively at a time. Stop the lubricant delivery once filling time **FT** elapses.

Multiple ducts can be filled simultaneously if filling is performed by selecting a defined volumetric flow via switched **SV1-SV4** on the MDS.

The volumetric flow must be stopped once filling time **TF** expires.

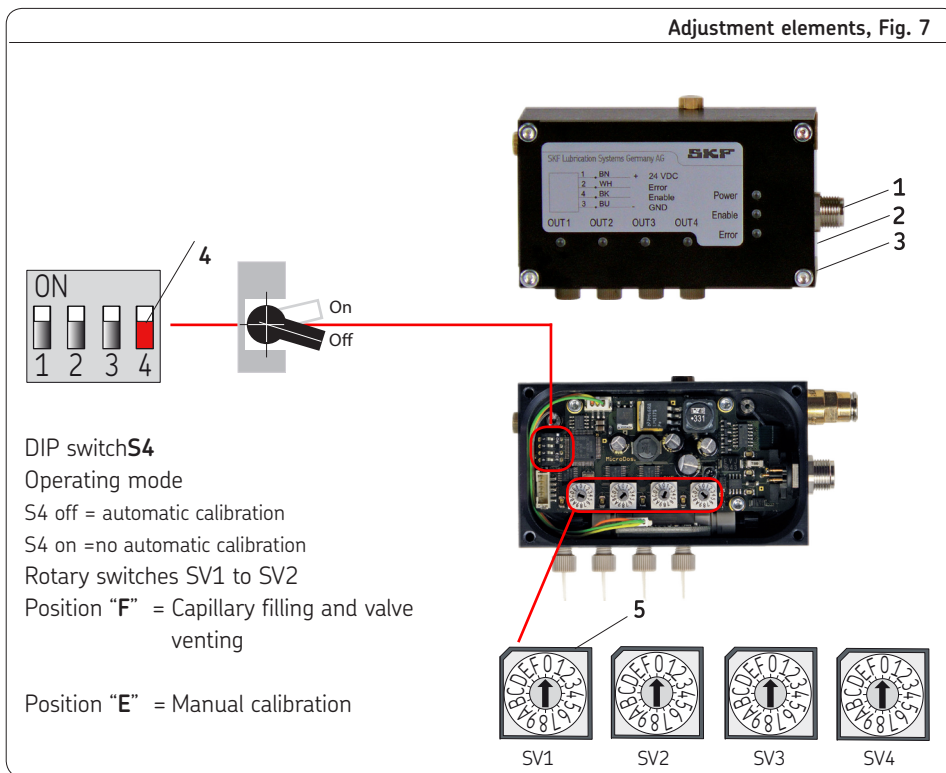

6.4 Calibration of the system

☞ See Figures 5 and 7

6.4.1 General

The MDU has a calibration function that is started automatically and/or executed manually by the user. The calibration compensates for influences on the system from the current application such as lengths of capillary lines, oil viscosity, temperature, etc. so that lubricant is always metered with high precision.

Whenever a calibration is started (whether manually or automatically), the latest calibration results stored in the MDU are used as initial values and then replaced with current results at the end of the calibration cycle.

The calibration results are stored in the MDU after each calibration and are retained even after operating voltage is disconnected.

Less than 1 minute is required for calibration of one outlet. During this time, the LED (green) assigned to the outlet is lit while the other outlets are disabled.

Calibration is performed only when the micro-metering unit is activated by the enable signal,

i.e., when the enable LED (yellow) is lit.

6.4.2 Manual calibration

Manual calibration is activated by switch position “E” on the SV rotary switch for the particular outlet (Fig. 7).

The calibration procedure can be stopped at any time by switching the rotary switch back to position “0”; the calibration cycle that has already been started still continues to completion. If a calibration cycle has ended and the rotary switch is still in position “E”, another calibration cycle is started after 5 seconds. The LED assigned to the outlet turns off during the pause between calibration cycles.

If the rotary switches for multiple outlets are in position “E”, calibration is performed for the outlet with the smallest number. Once the outlet undergoing calibration is stopped, the calibration procedure starts for the next outlet with the smallest number.

During commissioning, it is recommended that a manual calibration be performed with up to 3 cycles. This quickly achieves a high level of accuracy for the volumetric flow under the conditions of the application.

6.4.3 Automatic calibration

Automatic calibration begins during operation for all active outlets if a corresponding event occurs (Table 1, page 44).

By default, the micro-dosage system is set to automatic calibration. It can be deactivated via DIP switch 4 (Chapter 6.2.1, Table A, page 47).

Deactivation of automatic calibration is useful only in few cases, for example if air pressure and temperature are constant, or for special tests in which the quantity of lubricant delivered should not be influenced by the calibration process.

6.5 External adjustment of volumetric flow

☞ See Figures 8 to 10

The machining parameters of machine tool spindles can vary in the machining process. The spindle bearings are therefore subjected to different loads. The optimal amount of lubricant required for the bearings can vary depending on the particular load condition. Via the enable input, the micro-metering unit provides the ability to influence the quantity of lubricant delivered in the ongoing lubrication operation.

If the enable signal is constantly active, the MDU delivers the set (maximum) volumetric flow at its outlets (see Figure 8).

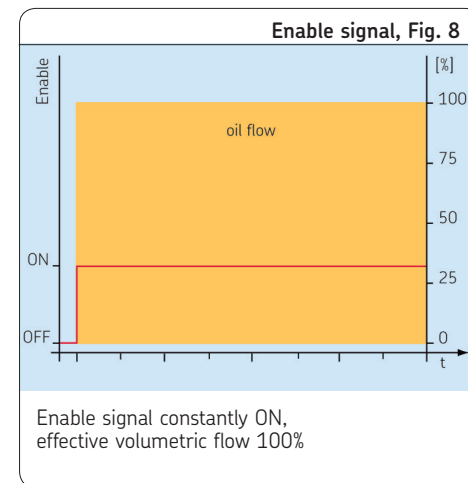

To reduce the volumetric flow to one-third or one-half (for example), the enable signal must be set to OFF for one third or one-half of the lubrication time (runtime), respectively (see Figure 9 and Fig. 10).

Increasing the off-time of the enable signal reduces the quantity of lubricant and the feeding continuity.

Procedure:

The maximum quantities of lubricant required for the bearings are set using the SV switches. The reduced volumetric flows are derived from the ON/OFF ratio generated at the enable input (Figs. 8 to 10, Table C). The ratio for ON/OFF cycling must be generated by the machine tool's control unit (Table C).

The reduction in volumetric flows generated by ON/OFF control affects all outlets.

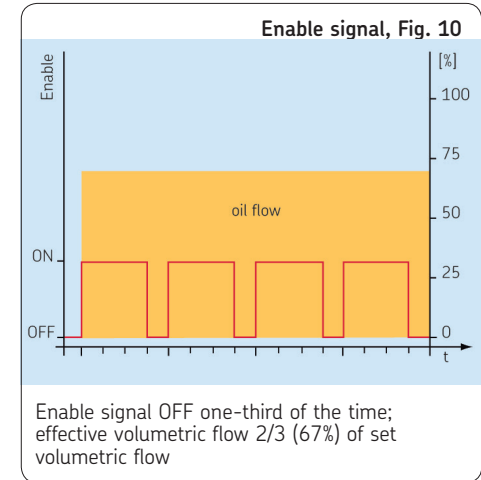
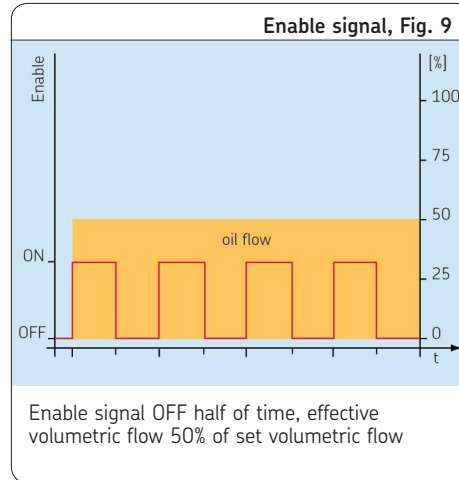

Defining the cycle times:

☞ See Table C

The time the MDU requires for all outlets to deliver lubricant once is referred to as the cycle time. It is 8 seconds and also the shortest ON-time. If the enable signal is set to ON, the lubrication cycle always starts at outlet 1. If the enable signal is set to OFF, the ongoing cycle always ends at outlet 4. A cycle that has been started is always performed completely, i.e., all outlets deliver lubricant once, even if the enable cycle has been set to OFF before the cycle time (8 seconds) ends.

Cycle times as listed in Table C can be used for external adjustment of the volumetric flow.

Table C

Cycle times for reducing volumetric flow via the enable signal

Cycle times for enable signal [seconds]								Effective volumetric flow as a percentage of set volumetric flow [%]	see Fig.
ON	-	OFF	-	ON	-	OFF	- ...		
8	-	0	-	8	-	0	- ...	100%	8
8	-	4	-	8	-	4	- ...	67%	10
8	-	8	-	8	-	8	- ...	50%	9

7. Shutdown and disposal

7.1 Temporary shutdown

The described product can be temporarily shut down by disconnecting the electrical, pneumatic, and/or hydraulic supply connections. The instructions in the "Assembly" chapter in these assembly instructions must be observed when doing so.

If the product is to be shut down for an extended period of time, follow the instructions in the Chapter "Transport, delivery, and storage" of these assembly instructions.

To recommission the product, follow the instructions in the "Assembly instructions" and "Commissioning" chapters in these assembly instructions.

7.2 Permanent shutdown

If the product will be permanently shut down, the local regulations and laws regarding the disposal of contaminated equipment must be observed.



Note!

Lubricants can contaminate soil and waterways. Lubricants must be used and disposed of properly. Observe the local regulations and laws regarding the disposal of lubricants.



The product can also be returned to SKF Lubrication Systems Germany GmbH for disposal, in which case the customer is responsible for reimbursing the costs incurred.

The parts are recyclable.

8. Maintenance and service

8.1 General information



Danger!

Centralized lubrication systems are pressurized during operation. Centralized lubrication systems must therefore be depressurized before starting assembly, maintenance, or repair work, or any machine modifications or machine repairs.

SKF Lubrication Systems Germany GmbH products are low-maintenance. However, all connections and fittings must be regularly inspected for proper seating to ensure proper function and to prevent hazards from arising.

If necessary, the product can be cleaned **only on the exterior** using mild cleaning agents that are compatible with the product's materials (non-alkaline, non-soap). For safety reasons, the product should be disconnected from the power supply and the hydraulic and/or compressed air supply.

Do not allow any cleaning agent to enter the interior of the product during cleaning.

It is not necessary to clean the interior of the product if it is operated normally and inter-compatible lubricants are used.

The interior of the product must be cleaned if incorrect or contaminated lubricant is accidentally filled into the product. If this occurs, please contact the Service department of SKF Lubrication Systems Germany GmbH for assistance.



Dismantling of individual parts of the product within the statutory warranty period is prohibited and voids any claims.



Only original spare parts from SKF Lubrication Systems Germany GmbH may be used. Unauthorized alterations to products and the use of non-original spare parts and accessories are prohibited and nullify the statutory warranty.

The maintenance intervals are determined depending on the specific conditions of the application. The criteria are machine-specific settings, ambient and operating conditions, and the purity of the lubricant used and the compressed air. Due to the application-specific conditions, the customer defines and maintains the maintenance intervals.

A visual fill level control of the lubricant reservoir must be performed at regular intervals. The control intervals are determined according to the quantity of lubricant required by the bearings. Due to the application-specific conditions, the customer defines and maintains the control intervals.

8.2 Maintenance and repair

The following maintenance and repair work must be performed on a regular basis:

- o Inspect the main lubricant line and the capillary lines.
- o Check the fill level in the lubricant reservoir.
- o Regularly inspect system components for leaks.
- o Inspect electrical cables for damage.
- o Inspect electrical connections and contacts.
- o Inspect electrical connections in case of malfunction notifications (on customer's control unit).
- o Visually inspect the bearing's lubrication.

SKF Lubrication Systems Germany GmbH shall not be held liable for damages resulting from improperly performed assembly, maintenance or repair work on the product.

If you encounter problems or have any questions, please contact our sales and service centers or our representatives abroad. A list with current addresses is available on the Internet at:

www.skf.com/lubrication

9. Malfunctions

9.1 General

Chapter 9.2 provides an overview of possible malfunctions and their causes. Contact the Service department of SKF Lubrication Systems Germany GmbH if you cannot remedy the malfunction.

 Dismantling of the product or individual parts thereof within the statutory warranty period is prohibited and voids any claims.

 All assembly, maintenance and repair work beyond this scope must be performed by the Service department of SKF Lubrication Systems Germany GmbH.

 Only original spare parts from SKF Lubrication Systems Germany GmbH may be used. Unauthorized alterations to products and the use of non-original spare parts and accessories are prohibited and nullify the statutory warranty.



Danger!

Performing work on products that have not been de-energized may result in serious injury or death. Assembly, maintenance, and repair work may only be performed on products that have been de-energized by qualified technical personnel. The supply voltage must be switched off before opening any of the product's components.



Danger!

Centralized lubrication systems are pressurized during operation. Centralized lubrication systems must therefore be depressurized before starting assembly, maintenance, or repair work, or any system modifications or system repairs.

9.2 Malfunctions, causes, and remedies

Fault notification, Table 2

Display	Fault status	Fault output	Cause
Error LED is off	No error	High signal 24 VDC	-
Error LED blinks red in combination with one or more green OUT LEDs	Volumetric flow error	Signal intervals of 250 ms low signal 250 ms high signal	Critically low lubricant level, air in the system, clogged capillary line, compressed air absent or insufficient
Error LED is on	Fault	Low signal 24 VDC	Hardware error

9.3 Questions and answers on using the SKF microdosage system

Questions and answers, Table 3, Part 1 of 2

Question	Answer
1 What happens if the compressed air supply for the lubricant reservoir is below 4 bar and is only 3.5 bar?	<p>The microdosage system typically functions properly even with a somewhat lower compressed air supply. The automatic calibration compensates for changes in operating parameters such as temperature, compressed air, and oil viscosity in a wide range.</p> <p>However, in a worst-case scenario for the other parameters such as low temperature and high oil viscosity, it is possible that the automatic calibration can no longer compensate for the deviations.</p>
2 What happens if the operating temperature is below the specified limit of 10°C?	<p>The microdosage system typically functions even at lower temperatures. At temperatures below 10°C, it must be ensured that the kinematic viscosity of the oil does not exceed the limit values provided in the data sheet.</p>

9.3 Questions and answers on using the SKF microdosage system

Questions and answers, Table 3, Part 2 of 2

Question		Answer
3	Is it necessary to eliminate air bubbles in the supply line or the capillary lines?	Yes, this is mandatory. It is absolutely essential to the proper functioning of the microdosage system that the oil fed from the lubricant reservoir (MDR) is free of air pockets. The system is not completely vented if air pockets are visible in the capillary lines. All areas of the system must be carefully vented again.
4	How can the microdosage unit monitor each of the four lubricant outlets simultaneously using just one flow sensor?	The microvalves generate metering pulses in the microsecond range in quick succession. By actuating the valves sequentially, the control unit can assign and evaluate the recorded sensor signal to the outlet.
5	How long does it take to fill the capillary line between the MDU and spindle at a volume of approx. 200mm ³ ? How long does the metering unit require for 200mm ³ in filling mode?	Filling a 1 m capillary line with an internal diameter of 0.5 mm and an internal volume of 200mm ³ takes between 30 seconds and 1 minute. The filling time depends on the viscosity of the oil used and the ambient temperature.
6	Do all lubricant outlets have to be used so that the system functions properly?	No, not all lubricant outlets need to be used. Leave the rotary switches for the unneeded outlets in position "0".
7	After operating voltage is connected, why do the "Enable" and "Error" LEDs light up in addition to the "Power" LED?	The status LED on the device lights up for 1 second after operating voltage is switched on so that the LED's function can be checked visually.
8	How can the function of the microvalves be checked?	It is easiest to check the valves in manual calibration mode. If the calibration has been started for a valve, the metering pulses can be detected acoustically assuming that the ambient noises are not too strong. See also Chapter 9.2 about error messages and the error LED.
9	Is it possible to supply multiple metering units with lubricant using a single lubricant reservoir?	Yes, appropriate branching of the lubricant line from the reservoir allows for the supply of multiple micro-metering units with lubricant from one reservoir. A requirement here is that the micro-metering units be pressurized at min. 4 bar.
10	What can I do if I want to supply more than 4 lubrication points?	Additional micro-metering units must be used to supply more than 4 lubrication points individually with lubricant.

10. Technical data

10.1 MDU micro-metering unit

Technical data, Table 4

Designation	
Temperature range	-10°C to +70°C
Mounting position	Any
Dimensions (WxLxD)	105 x 60 x 45 mm
Number of lubricant outlets	4, individually adjustable
Volumetric oil flow per outlet	0.5–5 mm ³ /min
Operating voltage for control unit	24 VDC M12x1
Electrical connection	
Protection class	IP67
Working temperature	10–50 °C
Operating viscosity	20 -500 mm ² /s
Electrical data	
Rated operating voltage	24 VDC
Enable input	0/24 VDC
Error signal output	0 VDC = error, 24 VDC = no error

10.2 MDR lubricant reservoir

Technical data, Table 5

Designation	
Dimensions (WxLxH)	110 x 313 x 360 mm
Contents	1 liter
Working temperature	+ 10 to +50 °C
Fill level monitor in reservoir	24 V DC
Compressed air supply	4.5 to 10 bar
Oil pressure (pressure on lubricant)	4 bar
Operating viscosity	20–500 mm ² /s
Pressure regulating valve, set to	16 bar
Weight (empty)	6 kg

11. Accessories

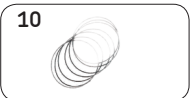
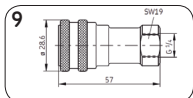
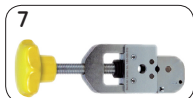
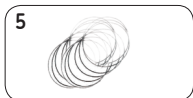
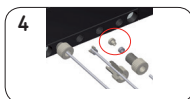
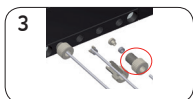

Accessories

Item	Designation	Order No.
MDU		
1	Mounting rail	886-570-005
2	Cable socket M12x1, straight Cable socket M12x1, straight with cable 5 m	179-990-371 179-990-600
3	1/16" adapter, plastic ¹⁾ (see page 29, item 5)	169-510-017
4	1/16" ferrule (sleeve) and clamp ring	169-510-018
5	Tube 1/16", 5 m	167-002-010
6	Tube 1/16", 25 m	167-002-011
7	1/16" tube cutter	169-000-335
MDR		
8	Filling pump, complete	169-000-262
9	Coupling socket (for filler coupling)	995-001-500
10	Plastic tube (main lubricant line)	WVN716-Ro6x1.25
Accessories for connection side (spindle)		
11	Socket union 1/4" for tube Ø1/16", brass ¹⁾ Socket union M6 for tube Ø1/16", brass ¹⁾	857-120-002 857-120-001
12	Adapter M5 to 1/4"-28UNF, brass	847-120-001

1) Order No. 169-510-018 is always required for this material and must be ordered separately.

951-170-217-EN

September 2014

The contents of this publication are the copyright of the publisher and may not be reproduced in whole or in part without permission of SKF Lubrication Systems Germany GmbH. Every care has been taken to ensure the accuracy of the information contained in this publication. However, no liability can be accepted for any loss or damage, whether direct, indirect, or consequential, arising out of use of the information contained herein.

All SKF products may be used only for their intended purpose as described in these assembly instructions with associated operating instructions. If assembly/operating instructions are supplied together with the products, they must be read and followed. Not all lubricants can be fed using centralized lubrication systems. SKF can, on request, inspect the suitability of the lubricant selected by the user for pumping in centralized lubrication systems. Lubrication systems and their components manufactured by SKF are not approved for use in conjunction with gases, liquefied gases, pressurized gases in solution, vapors, or such fluids whose vapor pressure exceeds normal atmospheric pressure (1013 mbar) by more than 0.5 bar at their maximum permissible temperature.

Particular attention is called to the fact that hazardous materials of any kind, especially the materials classified as hazardous by EC Directive 67/548/EEC, Article 2, Para. 2, may only be filled into SKF centralized lubrication systems and components and delivered and/or distributed with such systems and components after consulting with and obtaining written approval from SKF.

SKF Lubrication Systems Germany GmbH

Motzener Strasse 35/37 · 12277 Berlin · Germany
PO Box 970444 · 12704 Berlin Germany
Tel. +49 (0)30 72002-0 · Fax +49 (0)30 72002-111
www.skf.com/lubrication

SKF Lubrication Systems Germany GmbH

2. Industriestrasse 4 · 68766 Hockenheim · Germany
Tel. +49 (0)62 05 27-0 · Fax +49 (0)62 05 27-101
www.skf.com/lubrication

